

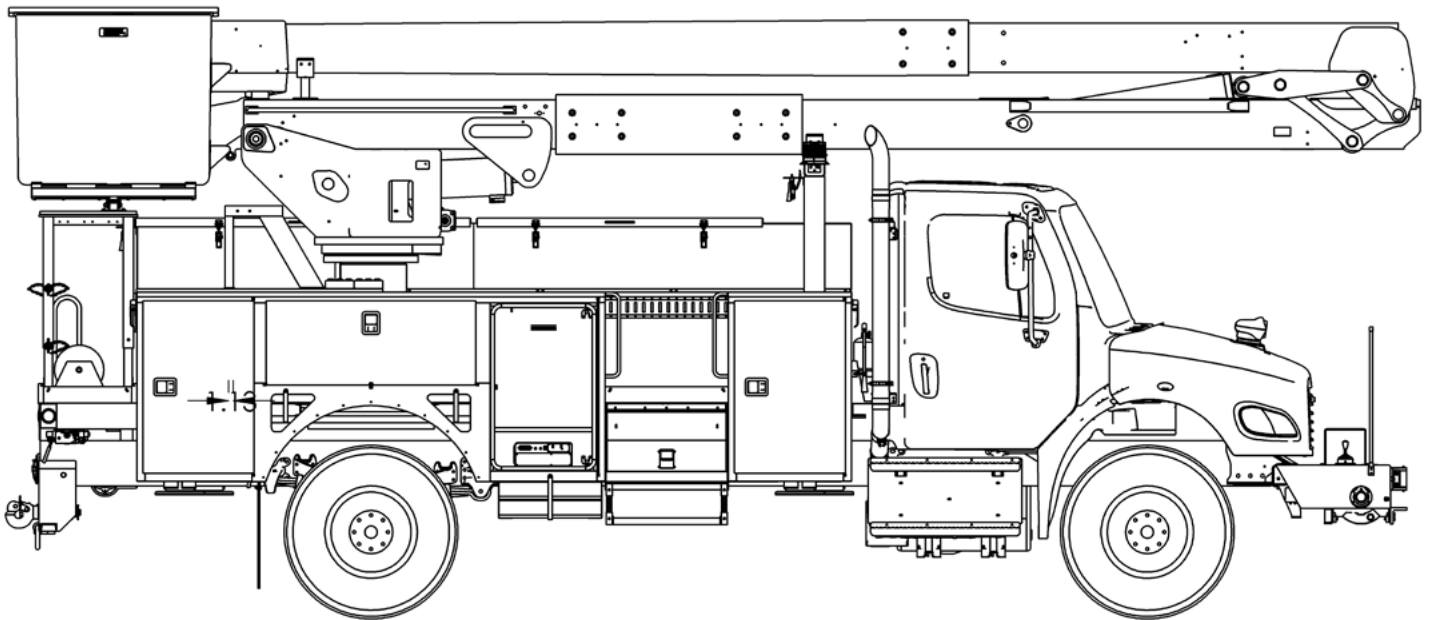

TECH TIPS

LOAD READINGS ARE NOT ACCURATE ON LOAD ALERT SYSTEM REV 2

NO. 119



SERVICE CALL:
LOAD READINGS ARE NOT
ACCURATE ON LOAD ALERT
SYSTEM REVISION 2



MODEL(S):
AERIAL UNITS WITH LAS



TOOLS NEEDED:
NONE

TEREX UTILITIES TECHNICAL SUPPORT TEAM

PHONE: 1-844-TEREX4U (1-844-837-3948) | EMAIL: UTILITIES.SERVICE@TEREX.COM



DANGER

Failure to obey the instructions and safety rules in the appropriate Operator's Manual and Service Manual for your machine will result in death or serious injury.

Many of the hazards identified in the Operator's Manual are also safety hazards when maintenance and repair procedures are performed.

DO NOT PERFORM MAINTENANCE UNLESS:

- ✓ You are trained and qualified to perform maintenance on this machine.
- ✓ You read, understand and obey:
 - manufacturer's instructions and safety rules
 - employer's safety rules and worksite regulations
 - applicable governmental regulations
- ✓ You have the appropriate tools, lifting equipment and a suitable workshop.

The information contained in this Tech Tip is a supplement to the Service Manual. Consult the appropriate Service Manual of your machine for safety rules and hazards.



TECH TIP 119 | RELEASED 09.01.2022 | VERSION 1.0
©TEREX UTILITIES. ALL RIGHTS RESERVED

CONTENTS

TECH TIP#119

TOC

4

| *Enter the password*

**INTRODUCTION
STEP 1 - STEP 2**

5

| *Calibration*

STEP 3

6

| *Jib calibration*

STEP 4

8

| *Troubleshooting*

STEP 7 - STEP 8

10

STEP 9

INTRODUCTION

Reference **Tech-tip 60** for additional information on the standard operation of LAS.

STEP 1

From the Operational Screen select the *Main Menu*.

Then click on *Diagnostics* and enter the password: 4321.

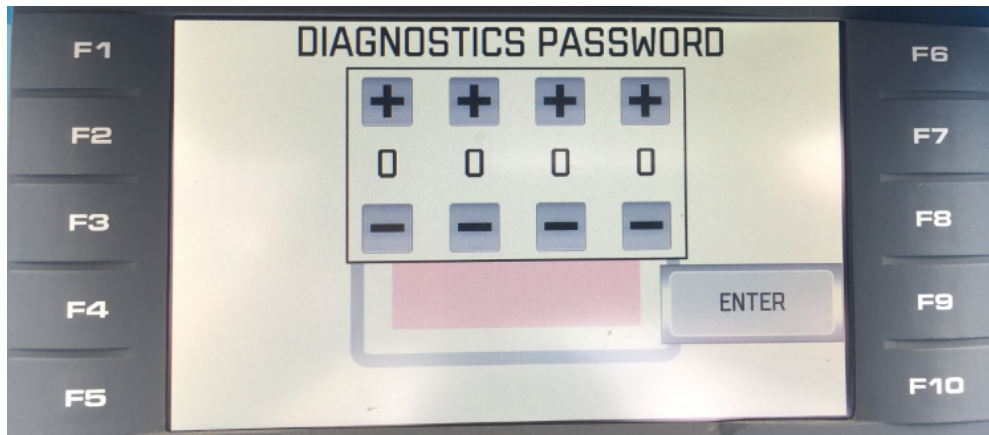

STEP 2

Once at Diagnostics Screen, select sensor status. While on the Sensor Status screen, raise the boom slightly and place a known load in the platform. Bounce the load and allow it to settle before taking a reading. Accuracy is to be within +/- 50#.

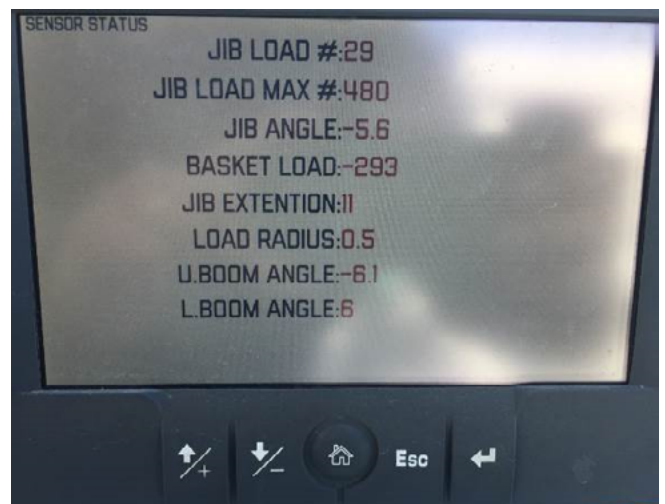
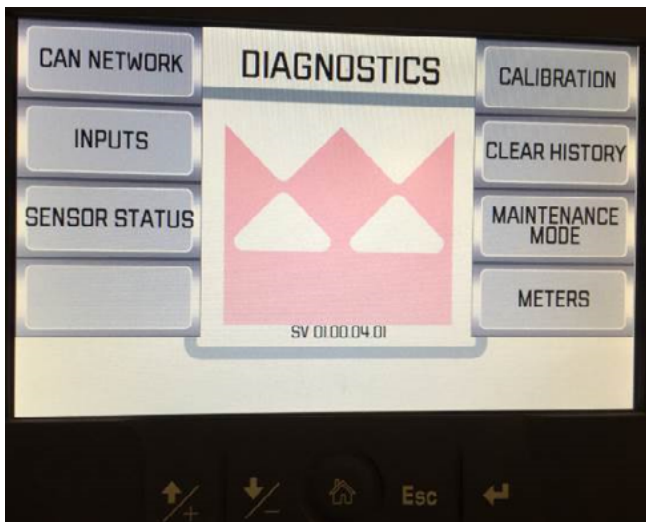

STEP 3

If the reading is not within the 50#, then recalibrate the platform according to the directions in the manual for the LAS system. For convenience, the directions are also provided below.

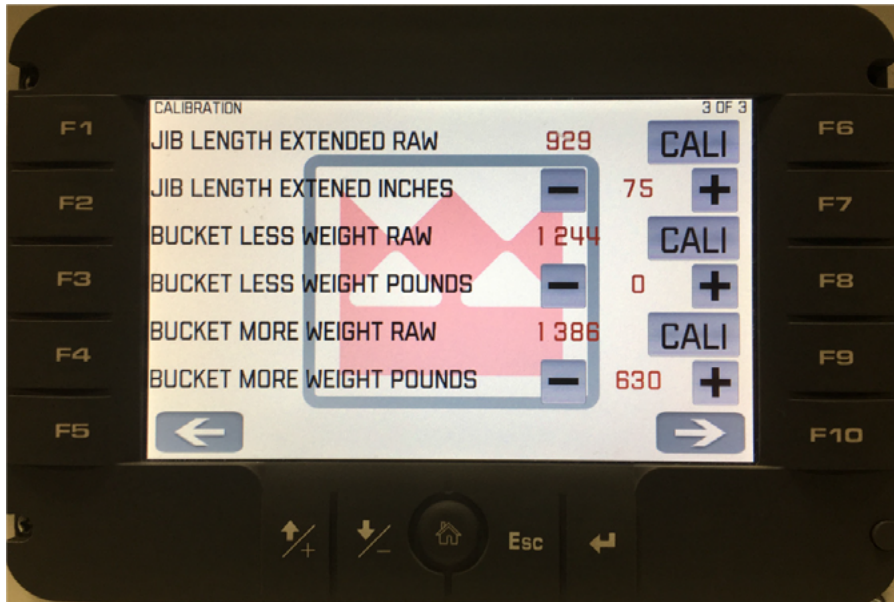

FIGURE 4 - Platform Load Calibration - Screen 3

PLATFORM LOAD CALIBRATION

- A known weight below maximum platform capacity will be needed. A weight that is 80-90% of platform capacity is ideal.
- Remove all weight from the platform including the platform liner.
- On calibration screen 3, set the Bucket Less Weight Pounds to 0 using the -&+ buttons.
- Press Cali next to the Bucket Less Weight Raw value. This will save that value.
- Load the known weight into the platform. The weight should be centered in the bottom of the platform.
- On the same screen set the Bucket More Weight Pounds to the value of the known weight in the platform using the -&+ buttons.
- Press Cali next to the Bucket More Weight Raw value.
- Go to the Sensor Status screen and verify the display is showing Basket Load within 50# of 0 empty and with a known weight in the basket. Make sure to do this with the basket out of the rest.
- To go back to any screens use the arrow back button.

STEP 4

Repeat the procedure with the jib, lifting a known weight off the ground approximately 6 inches. If the reading is not within $\pm 50\#$ then recalibrate.

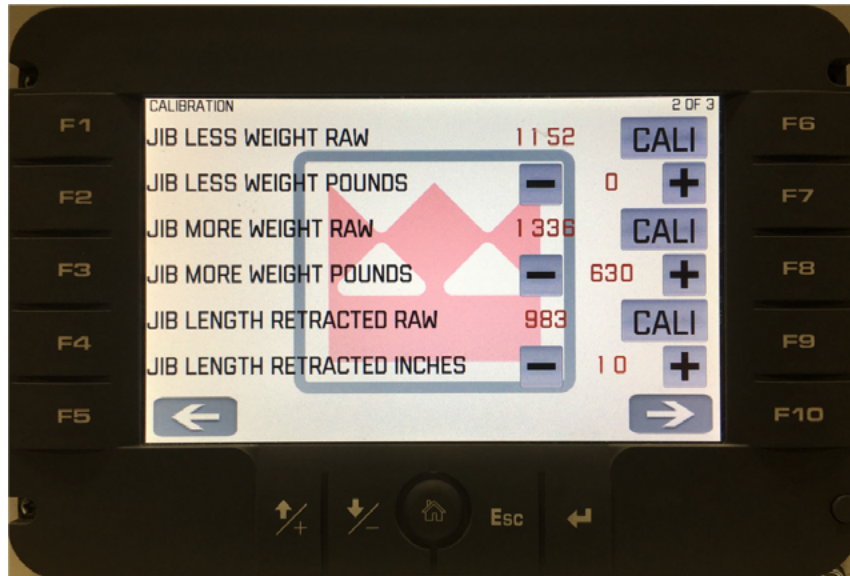

FIGURE 5 - Platform Load Calibration - Screen 2

- Position the booms and jib to achieve a load chart capacity larger than the test weight being used
- Use a known weight that is 80% to 90% of the maximum capacity shown on the load chart. The closer the weight is to the maximum value listed on the load chart the more accurate it will be. Reference the load chart on the display to help with this. The green box gives the capacity in the current boom configuration

LOAD CHART: OPTIMA HRX60						
MAXIMUM JIB LOAD (LBS)		2000	1500	750	500	500
		JIB CAPACITY AT LOAD RADIUS SHOWN (LBS)				
UPPER BOOM ANGLE	BASKET CAPACITY (LBS)	ZONE A				ZONE B
		LOWER BOOM TO 110 DEG.				
		0 FT	0-2 FT	2-4 FT	4-6 FT	>110
-60	700	1380	1340	750	500	500
-30	700	530	510	490	470	0
0	700	500	480	460	450	0
30	700	660	640	610	500	0
60	700	1850	1500	750	500	500
90	700	1130	1130	750	500	500
120	700	60	60	60	60	60
150	360	0	0	0	0	0
180	260	0	0	0	0	0

STEP 4 (Continued)

- Freely suspend the load line with no load attached
- On calibration screen 2, set the 'Jib Less Weight Pounds' to 0 using the -&+ buttons
- Press 'Cali' next to the 'Jib Less Weight Raw' value
- Lift the known weight using the jib winch line
- On calibration screen 2, set the 'Jib More Weight Pounds' to the value of the known weight on the jib load line using the -&+ buttons
- Press 'Cali' next to the 'Jib More Weight Raw' value
- On the Sensor Status screen verify the displayed Jib Load is within the 50# tolerance. Check both with no load on the line and with a known load on the line

STEP 5

Review the Sensor Status screen to verify all the sensors are working properly. The sensors can be checked by changing the boom angle, jib extension, and jib angle and verifying that the values change.

STEP 6

Review the Sensor Status screen to verify the values are accurate as the jib is extended and retracted. It should read from 10" to 75"

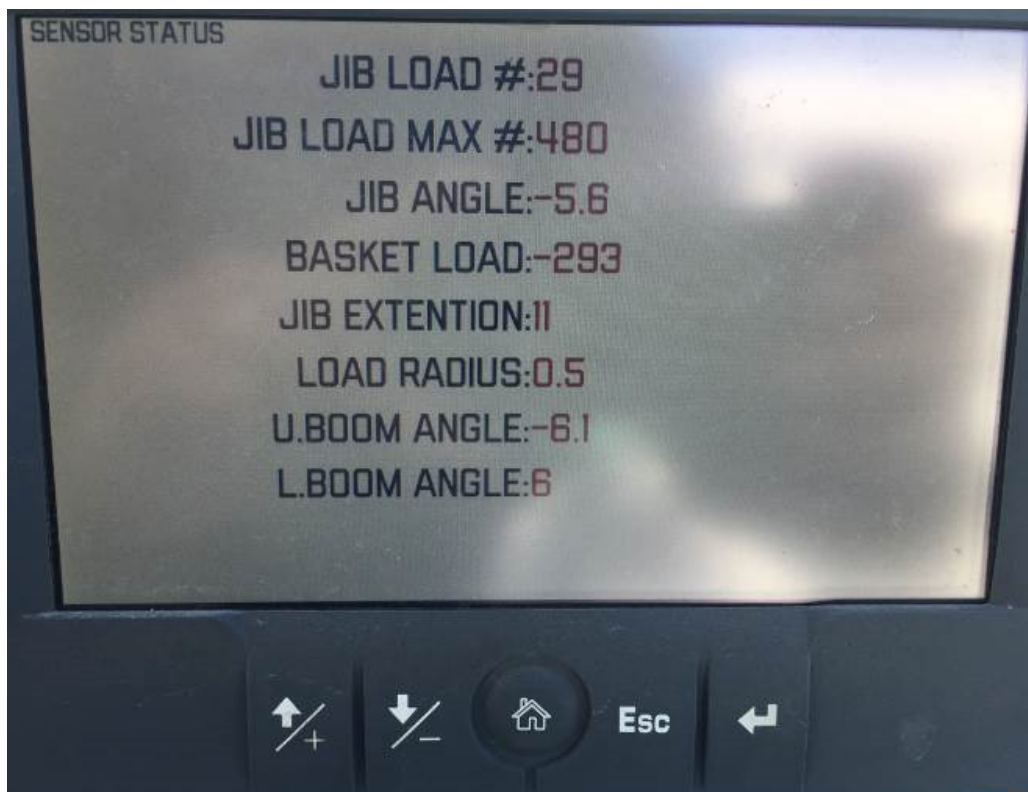

STEP 7

If the readings do not reflect the actual measurements, check the rack and pinion gear under the jib covers for proper engagement to the jib. The gear cannot be allowed to jump a tooth anywhere throughout the stroke of the jib.



STEP 8

Consult the “Input Diagnostics” screen to verify the value for jib extension changes as the jib is extended and retracted. Use the back arrow button to get to these screens. If it does not change or the value is erratic, then the sensor or the wiring for the sensor is bad.

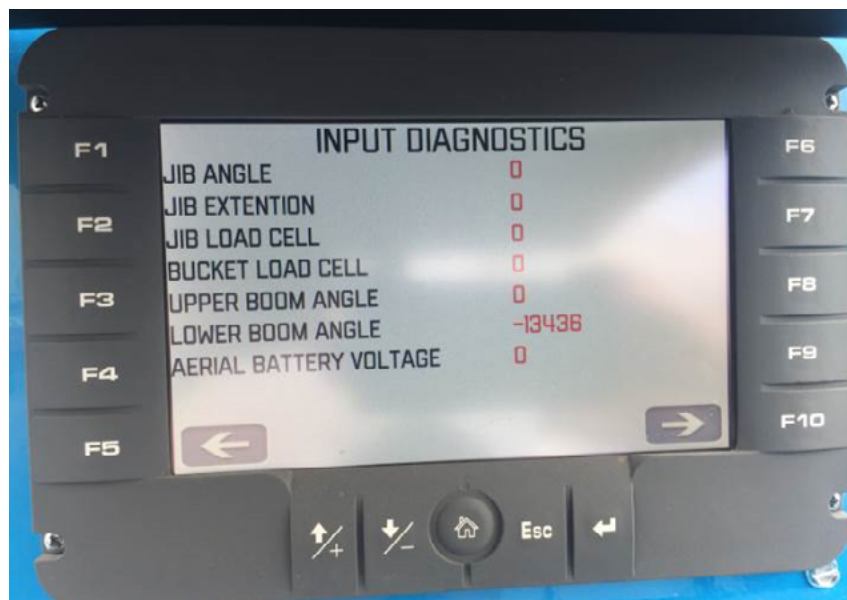

STEP 8 (Continued)

Note: The sensor is a 10 turn potentiometer, it is important that it not be turned past the internal stops. When turning the sensor do not force it beyond the stops. It should feel smooth all the way from one stop to the other. If it does not, replace the sensor.



When installing the sensor, the jib should be fully retracted. Before installing the extension sensor assembly on the jib, adjust the sensor position as follows. Looking down at the potentiometer, turn the gear counter-clockwise until it stops, then turn the gear back clockwise $\frac{1}{4}$ turn.

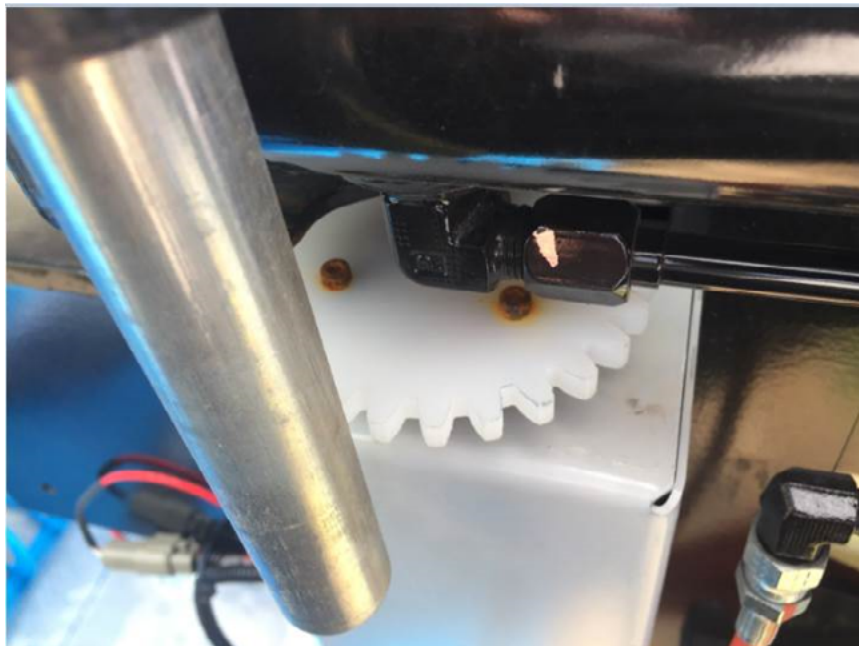

STEP 9

- With the booms in the rest, rotate the jib to be horizontal. Retract the jib fully, both the hydraulic extension and manual repining.
- On calibration screen 2, set the 'Jib Length Retracted Inches' to 11 using the -&+ buttons.
- Press 'Cali' next to the 'Jib Length Retracted Raw' value.
- Fully extend the jib using the extension and repining manually.

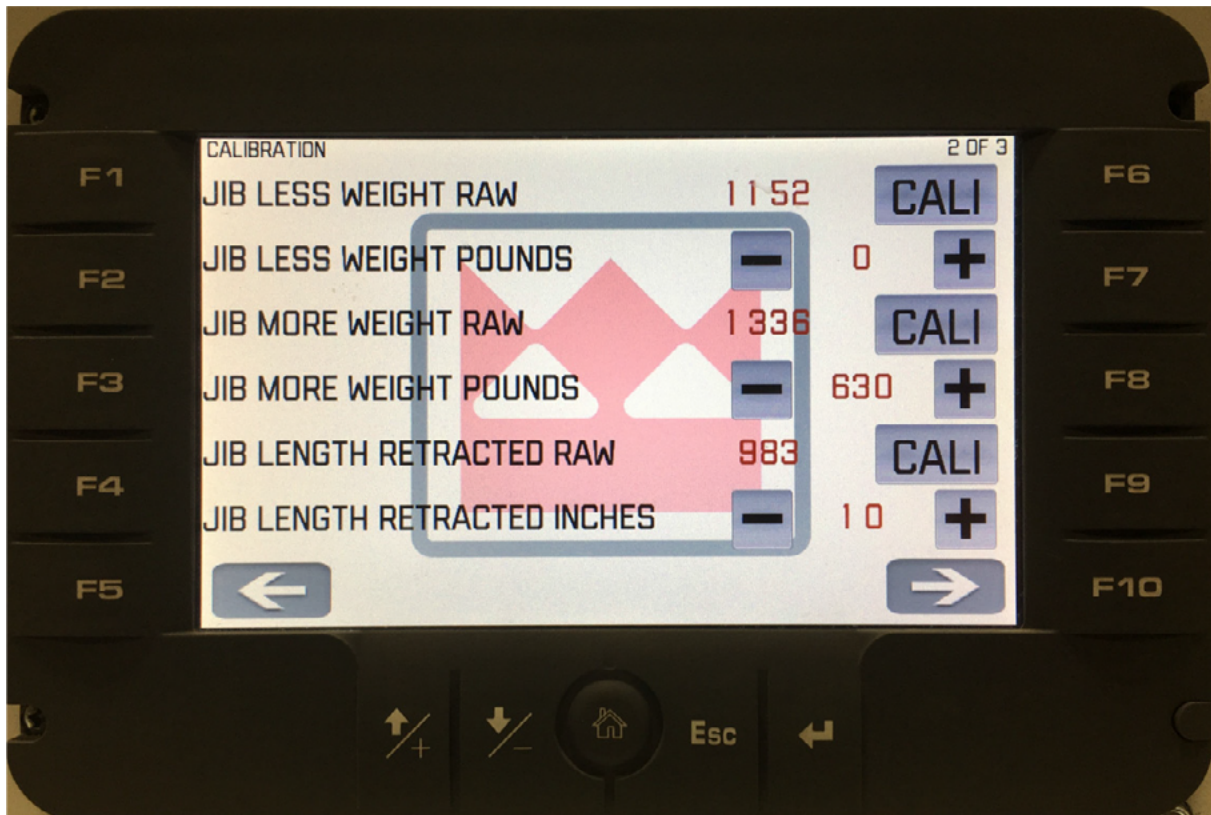

STEP 9 (Continued)

- On calibration screen 3, set the 'Jib Length Extended Inches' to 75 using the -&+ buttons.
- Press 'Cali' next to the 'Jib Length Extended Raw' value.
- Go back to the sensor status screen and verify that the measurement changes as you retract and extend the jib +/- 2 inches. The measurement is taken from the center of the platform leveling shaft to the load line.

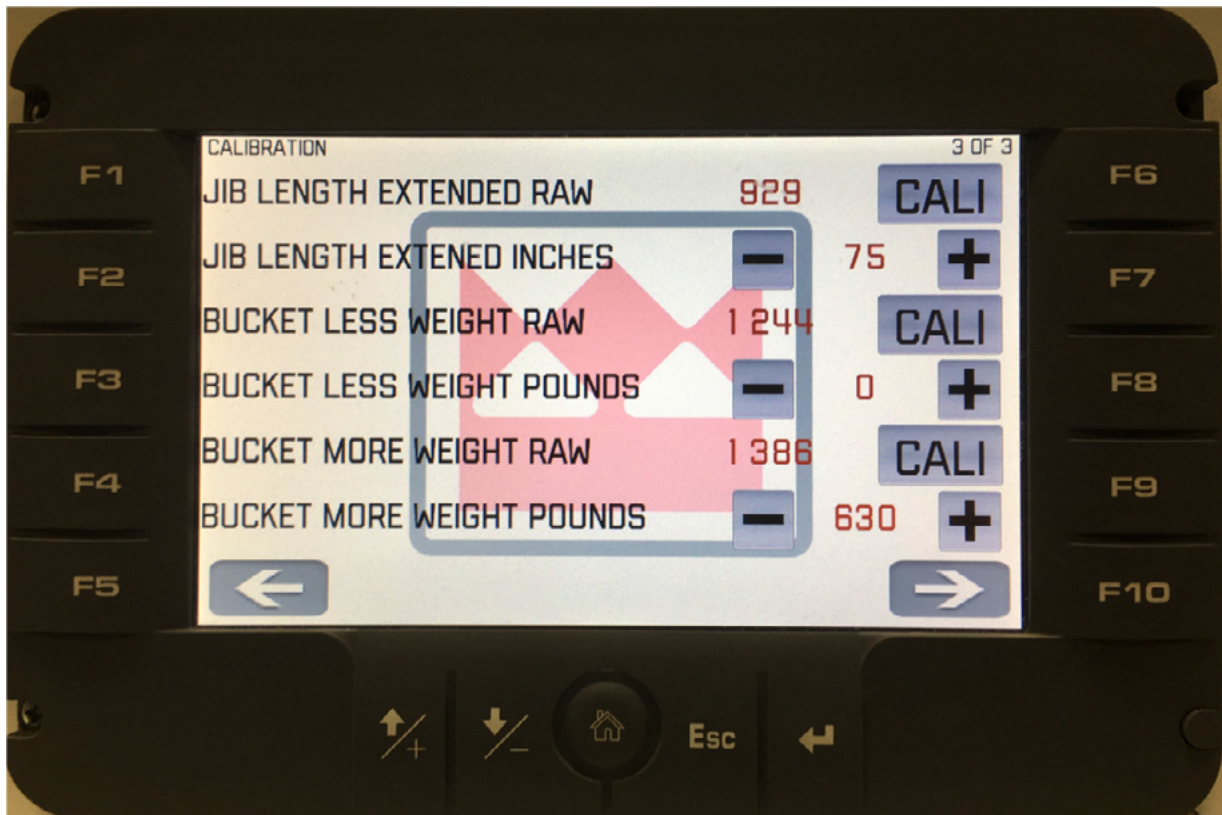



FOR FURTHER ASSISTANCE,
CONTACT THE TEREX UTILITIES TECHNICAL SUPPORT TEAM
PHONE: **1-844-TEREX4U (1-844-837-3948)** | EMAIL: **UTILITIES.SERVICE@TEREX.COM**
